

# LBH-LLH

zone 1

zone 2

EEx d IIB

II2G

-20°C

+40°C



## KAPAKLI DİRSEK ELBOW

Özellikleri : Kapaklı dirsek

Features : Pull elbow

Materyaller : Hafif alaşım

Materials : Light alloy



Ø"	A	B	C	Kod Code
1/2	132	50	69	LBH 1
3/4	132	50	69	LBH 2
1	129	60	69	LBH 3
1 1/2	175	89	102	LBH 5
2	210	102	104	LBH 6
3	425	147	142	LBH 8
4	600	160	180	LBH 9

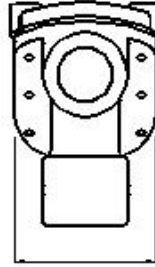

C

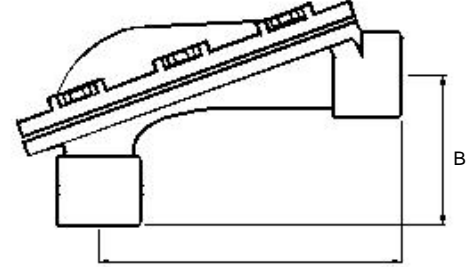

A

Ø"	A	B	Kod Code
1/2	190	48	LLH 1
3/4	190	48	LLH 2
1	190	57	LLH 3
1 1/2	360	75	LLH 5
2	360	86	LLH 6
3	493	118	LLH 8
4	860	158	LLH 9

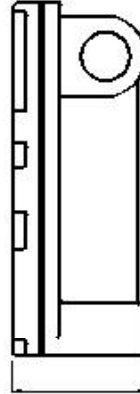

B

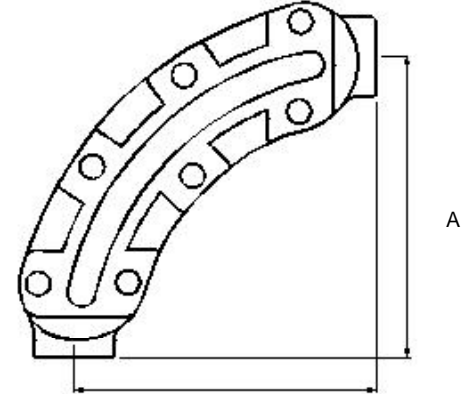

A

# KONDULET

## KABLO ÇELME KUTUSU PULL BOX

Özellikler: IP 65 kablo çekme kutusu

Features : IP 65 pull box

Materiali : Hafif alaşım – EPDM conta

Materials : Light alloy (aluminium) - EPDM gasket

Kod Code	Ø" Imb. Hubs Ø"	A	B	C	D
.. 17	1/2	94	42	16	38
.. 27	3/4	94	42	16	38
.. 37	1	114	48	19	48
.. 57	1 1/2	138	64	22	64
.. 67	2	160	84	26	84
.. 87	3	313	106	27	106

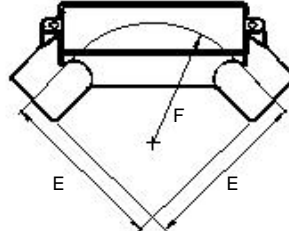
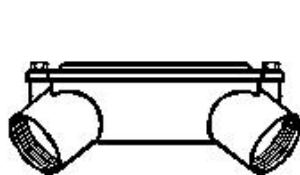
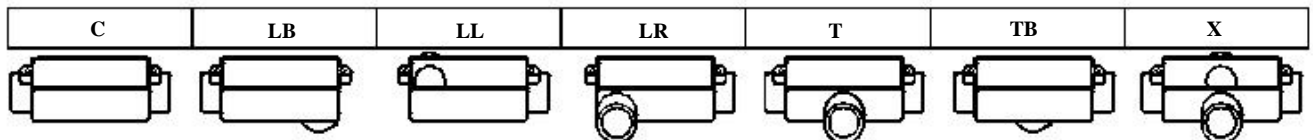
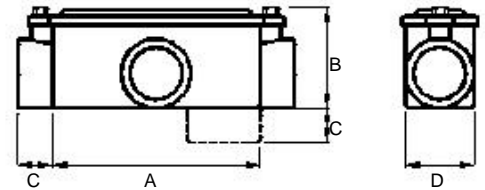

Kod Code	Ø" Imb. Hubs Ø"	D	E	F
LU 17	1/2	38	76	80
LU 27	3/4	38	76	80
LU 37	1	48	96	100
LU 57	1 1/2	64	150	156
LU 67	2	84	190	200
LU 87	3	106	330	350